

POS	Bauteil	Stück
1	Anlenkplatte Spurstange	1
2	Achse Lenker	1
3	Anschluss Vorbau Achse Lenker	2



AAZZAA
Free Trike Project
www.aazaa.de

GEWICHT: 268.49g

BENENNUNG:

Lenkplatte mit Vorbauanschluss

THE INFORMATION CONTAINED IN THIS DRAWING IS THE SOLE PROPERTY OF AAZZAA. ANY REPRODUCTION IN PART OR AS A WHOLE WITHOUT THE WRITTEN PERMISSION OF AAZZAA IS PROHIBITED. DRAWING IS UNDER CREATIV COMMON LIZENSE.

	NAME	SIGNATUR	DATUM
GEZEICHNET	F.Hein	FH	12.01.2015

WERKSTOFF:
1.0570 (S355J2G3)
1.1193 (C45G)

MASSSTAB: 1:1

BLATT 1 VON 1

A3

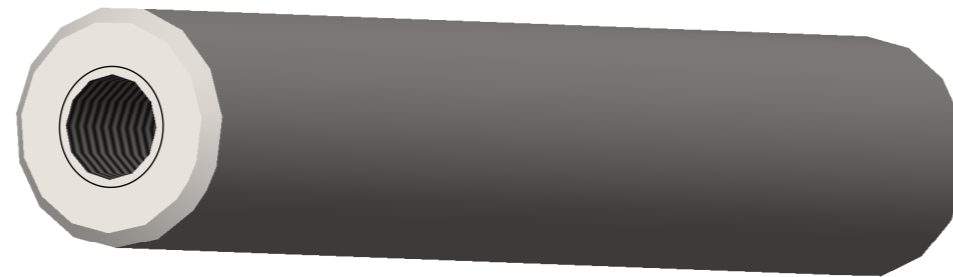
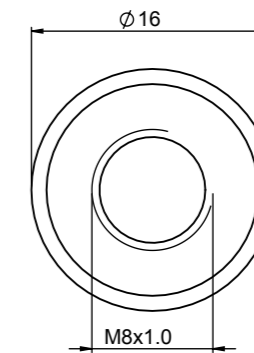
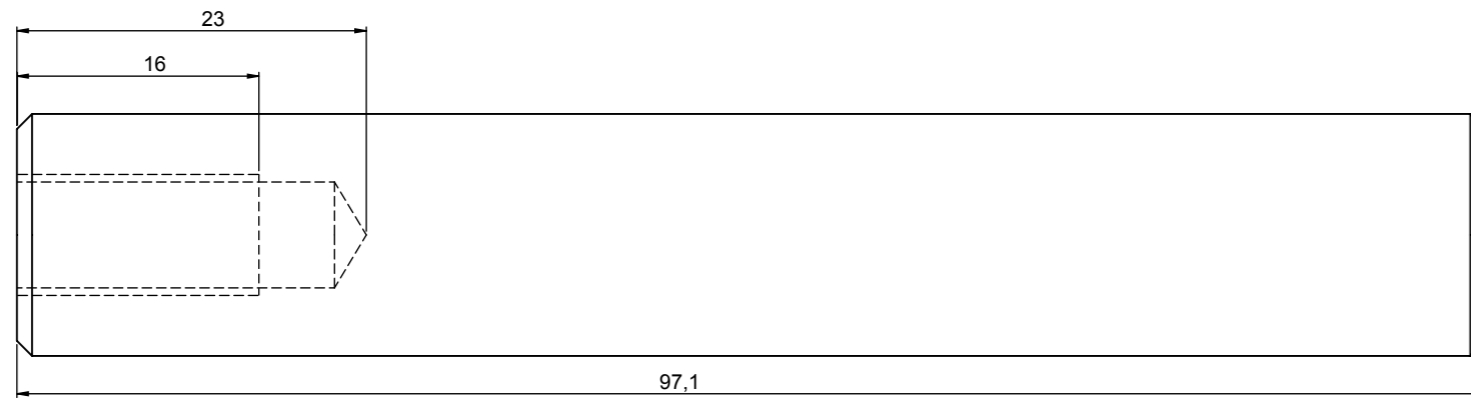

AAZZAA
Free Trike Project
www.aazzaa.de

GEWICHT: 145.39g

BENENNUNG:

Achse Lenker

THE INFORMATION CONTAINED IN THIS DRAWING IS THE SOLE PROPERTY OF AAZZAA. ANY REPRODUCTION IN PART OR AS A WHOLE WITHOUT THE WRITTEN PERMISSION OF AAZZAA IS PROHIBITED. DRAWING IS UNDER CREATIV COMMON LIZENSE.

	NAME	SIGNATUR	DATUM
GEZEICHNET	F.Hein	FH	18.01.2015

WERKSTOFF:
1.1193 (C45G)

A3

MASSSTAB: 2:1

BLATT 1 VON 1

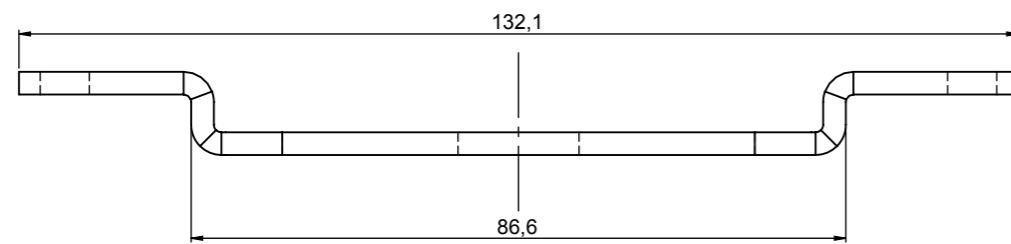
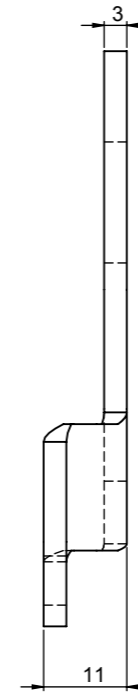
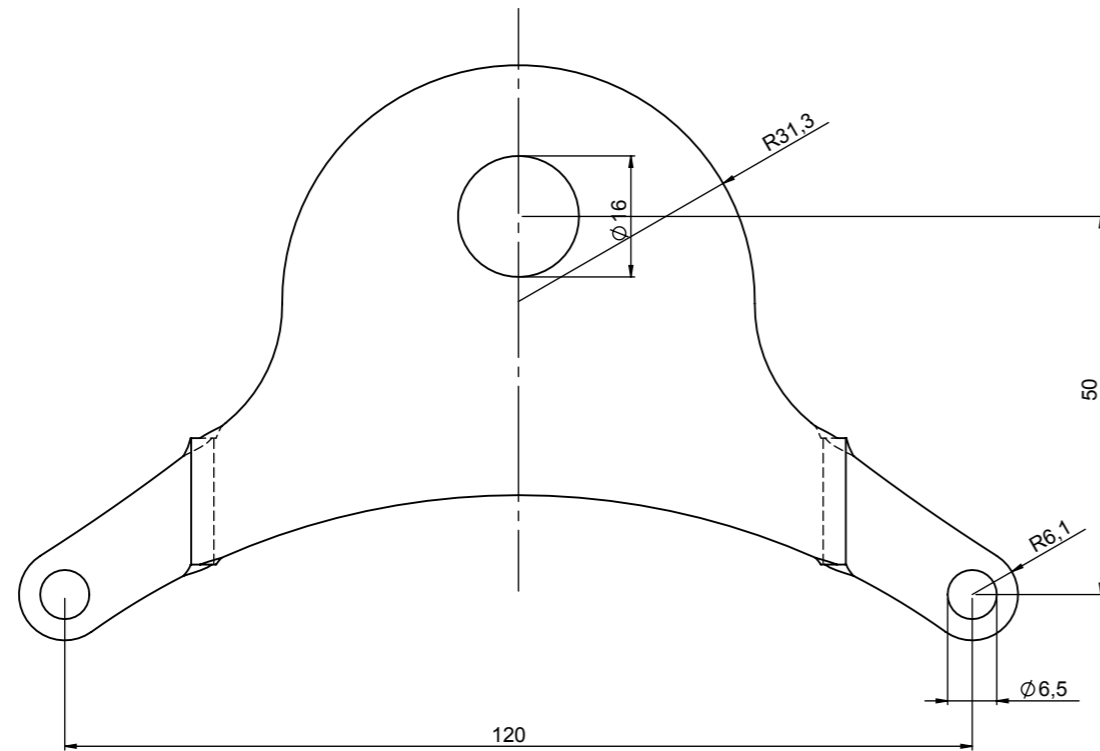

THE INFORMATION CONTAINED IN THIS DRAWING IS THE SOLE PROPERTY OF AAZZAA. ANY REPRODUCTION IN PART OR AS A WHOLE WITHOUT THE WRITTEN PERMISSION OF AAZZAA IS PROHIBITED. DRAWING IS UNDER CREATIV COMMON LIZENSE.

	NAME	SIGNATUR	DATUM
GEZEICHNET	F.Hein	FH	09.01.2015

		AAZZAA Free Trike Project www.aazaa.de	
GEWICHT: 99.35g		BENENNUNG: Anlenkplatte Spurstange	
WERKSTOFF: 1.0570 (S355J2G3)		A3	
MASSSTAB: 1:1		BLATT 1 VON 1	

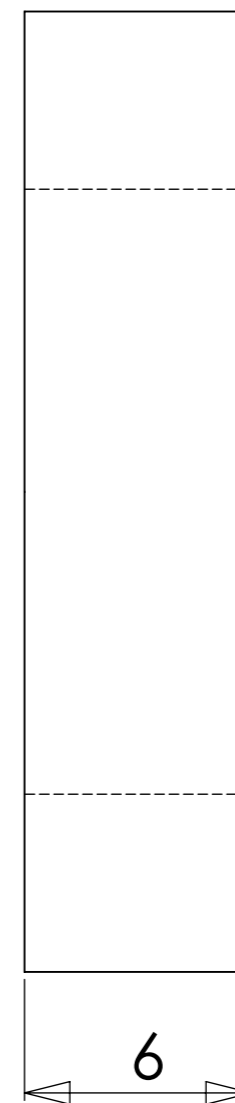
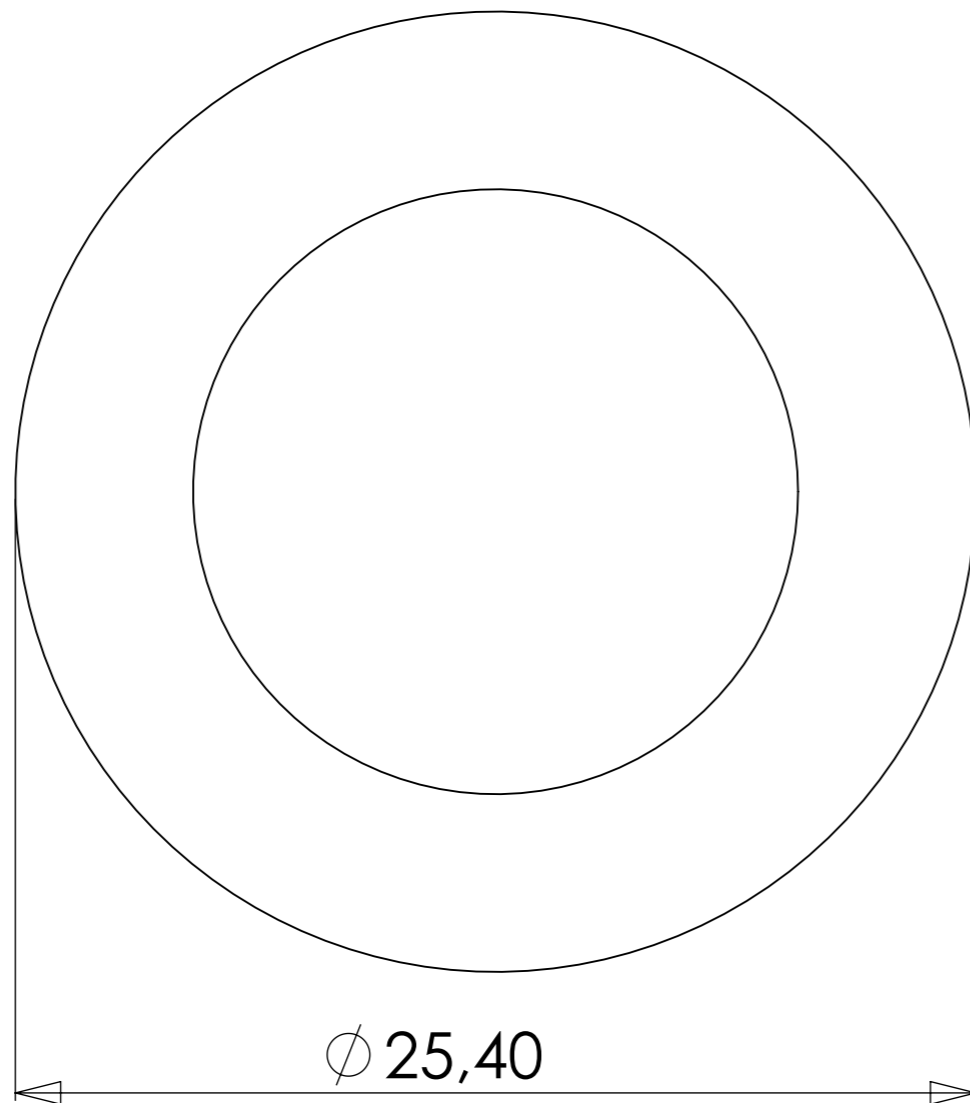

THE INFORMATION CONTAINED IN THIS DRAWING IS THE SOLE PROPERTY OF AAZZAA. ANY REPRODUCTION IN PART OR AS A WHOLE WITHOUT THE WRITTEN PERMISSION OF AAZZAA IS PROHIBITED. DRAWING IS UNDER CREATIV COMMON LIZENSE.

	NAME	SIGNATUR	DATUM
GEZEICHNET	F.Hein	FH	09.01.2015



AAZZAA
Free Trike Project
www.aazaa.de

GEWICHT: 14.30g

BENENNUNG:

Anschluss Vorbau Achse Lenker

WERKSTOFF:
1.0570 (S355J2G3)

A3

MASSSTAB: 5:1

BLATT 1 VON 1

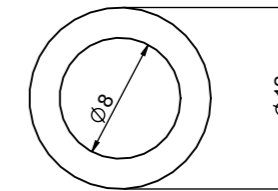
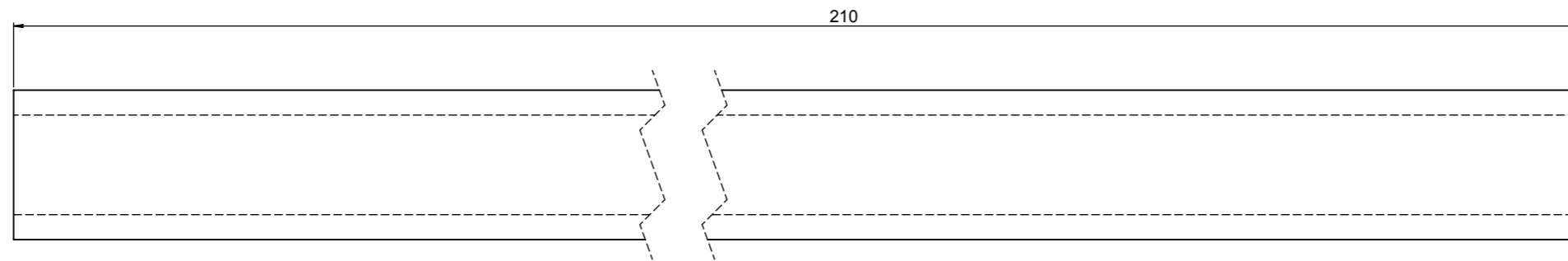

THE INFORMATION CONTAINED IN THIS DRAWING IS THE SOLE PROPERTY OF AAZZAA. ANY REPRODUCTION IN PART OR AS A WHOLE WITHOUT THE WRITTEN PERMISSION OF AAZZAA IS PROHIBITED. DRAWING IS UNDER CREATIV COMMON LIZENSE.

	NAME	SIGNATUR	DATUM
GEZEICHNET	F.Hein	FH	09.01.2015

		AAZZAA Free Trike Project www.aazaa.de	
GEWICHT: 35.10g		BENENNUNG: Spurstange	
WERKSTOFF: 3.3535 (EN-AW 5754)		A3	
MASSSTAB: 2:1		BLATT 1 VON 1	